



**USER'S MANUAL**  
*MANUEL DE L'UTILISATEUR*  
*MANUAL DEL USUARIO*

**VR-5535Z**

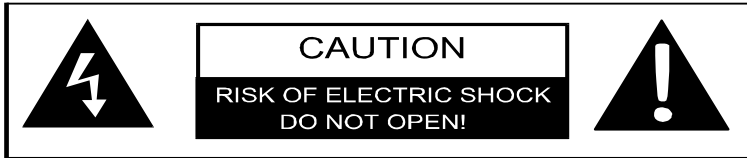

**TABLE OF CONTENTS**

1	<b>IMPORTANT INFORMATION</b>		2
2	<b>HOW TO INSTALL THE STAND</b>		4
3	<b>PREFACE</b>		5
4	<b>SAFETY PRECAUTIONS</b>		5
5	<b>CONTENTS</b>		7
6	<b>FRONT/BACK CONNECTIONS OF LCD TV</b>		8
7	<b>TV INSTALLATION</b>	Power Cord Connection	9
		Antenna Connection	9
		AV Connection	10
		YPbPr(component) Connection	10
		VGA(PC) Connection	11
		Service Port Function	11
		HDMI Connection	12
8	<b>REMOTE CONTROL</b>	Remote control instructions in TV mode	13
		Remote control setup	14
9	<b>MENU OPERATION</b>	SETUP WIZARD	15
		Operating the Menu	17
		PICTURE Menu	18
		AUDIO Menu	19
		TIME Menu	19
		SETUP Menu	20
		LOCK Menu	22
CHANNEL Menu	24		
10	<b>TROUBLESHOOTING</b>		26
11	<b>SPECIFICATIONS</b>		27

## IMPORTANT INFORMATION

---



The lightning flash with arrowhead symbol, within an equilateral triangle, is intended to alert the user to the presence of un-insulated dangerous voltage within the products enclosure that may be of sufficient magnitude to constitute a risk of electric to persons.



The exclamation point within an equilateral triangle is intended to alert the user to the presence of important operating and maintenance (servicing) instruction the literature accompanying the appliance.

**CAUTION:** USE OF ANY CONTROLS, ADJUSTMENTS, OR PROCEDURES OTHER THAN THOSE SPECIFIED HEREIN MAY RESULT IN HAZARDOUS RADIATION EXPOSURE.

**CAUTION:** These servicing instructions are for use by qualified service personnel only. To reduce the risk of electric shock, do not perform any servicing other than that contained in the operating instructions unless you are qualified to do so.

Refer to service manual for servicing instructions.

## Important Safety Instructions

### Note:

1. Read these instructions.
2. Keep these instructions.
3. Heed all warnings.
4. Follow all instructions.
5. Do not use near water.
6. Clean only with dry cloth.
7. Do not block any ventilation openings. Install in accordance with the manufacturer's instructions.
8. Do not install near any heat sources such as radiators, heat registers, stoves, or other apparatus (including amplifiers) that produce heat.
9. Do not defeat the safety purpose of the polarized or grounding-type plug. A polarized plug has two blades with one wider than the other. A grounding type plug has two blades and a third grounding prong. The wide blade or the third prong are provided for your safety. If the provided plug does not fit into your outlet, consult an electrician for replacement of the obsolete outlet.

## IMPORTANT INFORMATION

10. Protect the power cord from being walked on or pinched particularly at plugs, convenience receptacles, and the point where they exit from the apparatus.
11. Only use attachments / accessories specified by the manufacturer.
12. Use only with the cart, stand, tripod, bracket, or table specified by the manufacturer, or sold with the apparatus.  
When a cart is used, use caution when moving the cart / apparatus combination to avoid injury from tip-over.



13. Unplug this apparatus during lightning storms or when unused for long periods of time.
14. Refer all servicing to qualified service personnel. Servicing is required when the apparatus has been damaged in any way, such as power-supply cord or plug is damaged, liquid has been spilled or objects have fallen into the apparatus, the apparatus has been exposed to rain or moisture, does not operate normally, or has been dropped.
15. Apparatus shall not be exposed to dripping or splashing and that no objects filled with liquids, such as vases, shall be placed on the apparatus.
16. WARNING: To reduce the risk of fire or electric shock, do not expose this apparatus to rain or moisture.
17. Mains plug or appliance coupler is used as the disconnect device, shall be readily operable.
18. The apparatus shall be connected to a MAINS socket outlet with a protective earthing connection.
19. WARNING: The batteries shall not be exposed to excessive heat such as sunshine, fire or the like.
20. The ON-MODE Power under Home Mode should be less than 108.0W.
21. The Sleep Mode power should be less than 1.0W.
22.  This equipment is a Class II or double insulated electrical appliance. It has been designed in such a way that it does not require a safety connection to electrical earth.
23.  Lamp(s) inside this product contain mercury and must be recycled or disposed of according to local, state or federal laws.

This Westinghouse product has earned the Energy Star® for meeting U.S. Federal energy efficiency guidelines as set by the Department of Energy and Environmental Protection agency. The Energy Star® program exists to provide energy saving guidelines and help promote energy efficient products and practices. Changes to certain features, settings and functions of this TV can change and/or increase its power consumption. Depending on how settings are changed, power consumption may exceed the limits required for Energy Star® qualification. This Westinghouse TV will operate at optimal energy efficiency in "Home" mode.

# How to install the stand!

## Main accessories:

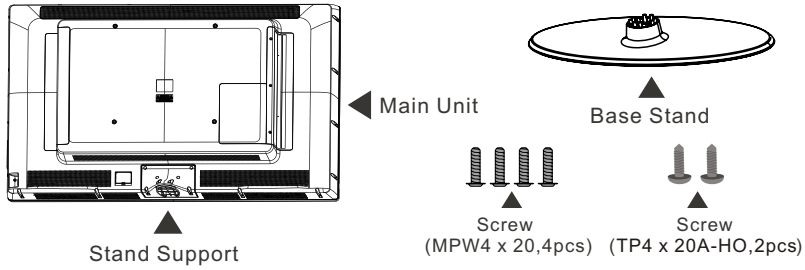

## Installation Steps:

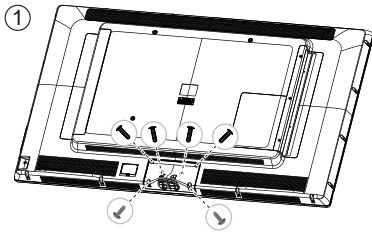

Take out the main unit and the base stand from the carton, Unscrew the 6 screws (4PCS MPW4 x 12/ 2PCS TP4 x 20A-HO) to remove the stand support from the main unit.

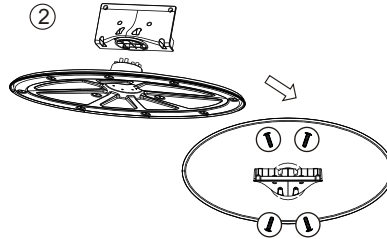

Connect the stand support and the base stand with 4PCS of MPW4 x 20 screws.

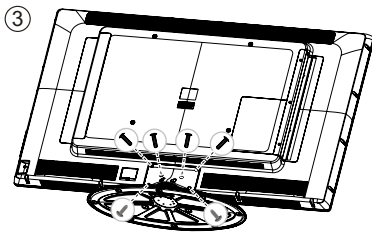

Screw back the 6 screws which were removed from step1 (4PCS MPW4 x 12/ 2PCS TP4 x 20A-HO) to connect the main unit and the stand support.

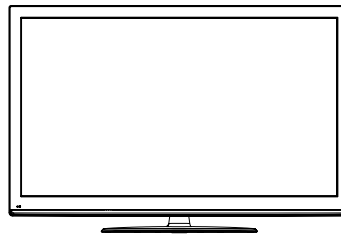

### 3. PREFACE

Thank you for buying this TV! Please read this manual thoroughly before operating the TV. Make sure the TV was not damaged in transit. Should the TV be damaged, do not install it and contact your dealer. Check that you have all the accessories according to the model.

### 4. SAFETY PRECAUTIONS



Put the TV on a stable surface.



Do not place any material on the TV.

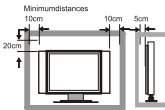

Do not use the TV with fixtures other than those provided or suggested by the manufacturer.



Do not block or cover the ventilation openings on the TV. If you have a wall mount, check that it is steady.



Power cord and cables must be properly routed and protected to prevent people from stepping on them and causing the TV to fall.

## SAFETY PRECAUTIONS

---

English



Keep the TV dry and away from humidity.

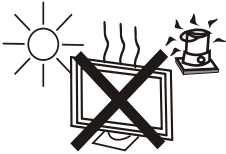

Keep the TV away from heat sources.



Unplug the TV before cleaning it. Do not use solvent or liquid to clean the TV.

Only clean the TV with a soft and dry cloth.

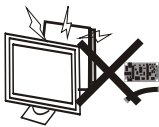

In case of troubleshooting, do not use spare parts other than those suggested by the manufacturer. Using inadequate spare parts can lead to electric shocks, short-circuits, fire or other incidents.



Unplug the TV during lightning storms or when unused for long periods of time.



**5. CONTENTS**

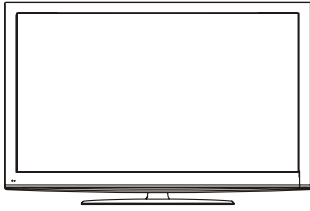

**LCD TV SET**



**Remote Control**

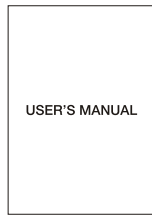

**USER'S MANUAL**

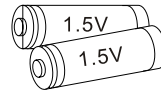

**AAA Batteries**

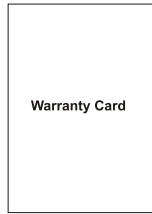

**Warranty Card**

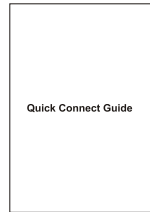

**Quick Connect Guide**

## 6. FRONT/BACK CONNECTIONS OF LCD TV

### Front View

English

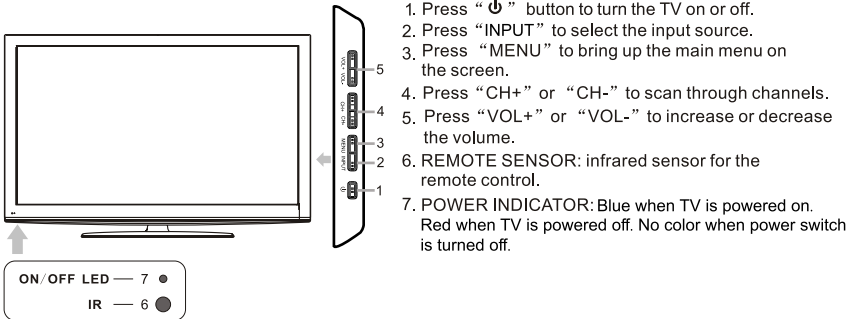

### Back View and Control Connections

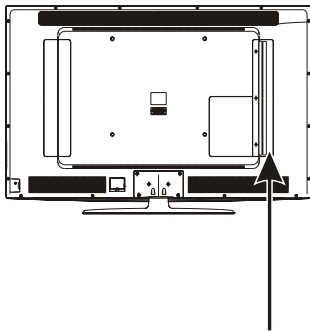

1. USB SERVICE: USB Port for Factory Use Only.
2. HDMI1/HDMI2/HDMI3: Connect the HDMI output jack of DVD.
3. VGA (PC): Connect the PC-RGB output jack of PC.
4. PC AUDIO: Connect the Audio output jack of PC.
5. YPbPr1/YPbPr2: Connect the YPbPr output.
6. S-VIDEO: S-VIDEO input.
7. COAX out: Connect the COAX receiver.
8. AV: Connect the Video output.  
L/R: For VIDEO audio.
9. RF IN: Connect the antenna.

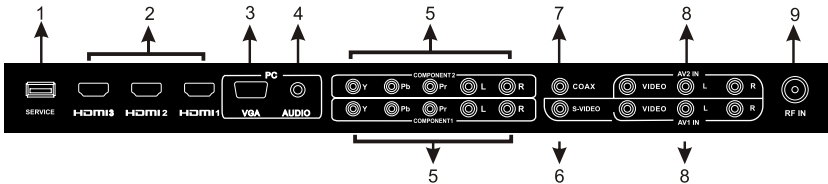

S-Video and AV1 share a set of audio.

## 7. TV INSTALLATION

### Power Cord Connection

- Connect the power cord correctly as shown.

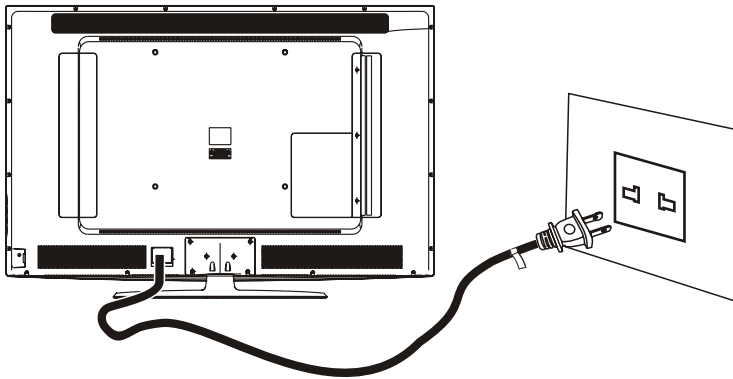

English

### Antenna Connection

To ensure good picture and sound, TV antenna system needs to be installed. The antenna system as shown can be sourced from TV equipment shops, which will provide service for correct installation and connection. After installation, insert the 75-ohm antenna plug into the antenna jack as shown.

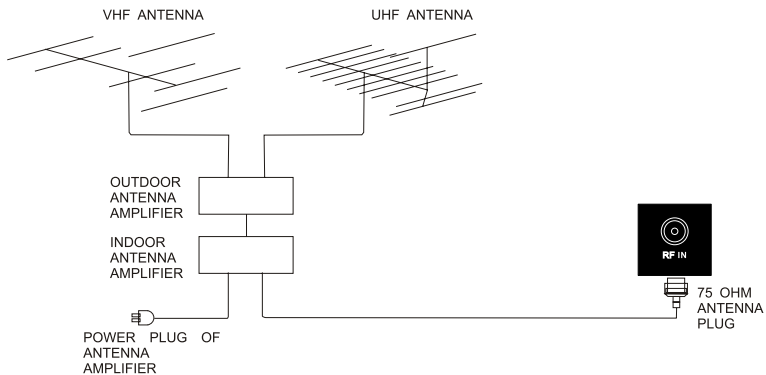

## TV INSTALLATION

### AV Connection

Connect the VIDEO and AUDIO output jack of the DVD or VCR to the VIDEO jacks on the set using the RCA cable. Match the jack colors: Video is yellow, Audio left is white, and Audio right is red. Select the AV input source using the SOURCE button on the remote control.

English

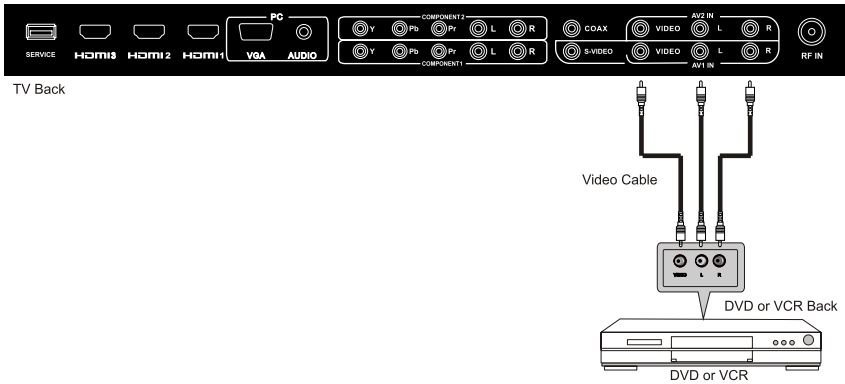

### YPbPr (Component) Connection

Connect the YPbPr output of the DVD or VCR to the YPbPr input on the set. The picture quality is improved; compared to connecting a regular VCR to the video input. Connect the Audio output of the DVD or VCR to the Audio input jacks on the set using the RCA cable. Match the jacks colors :Y is green,Pb is blue,Pr is red,Audio left is white and Audio right is red. Select component input source using the SOURCE button on the remote control.

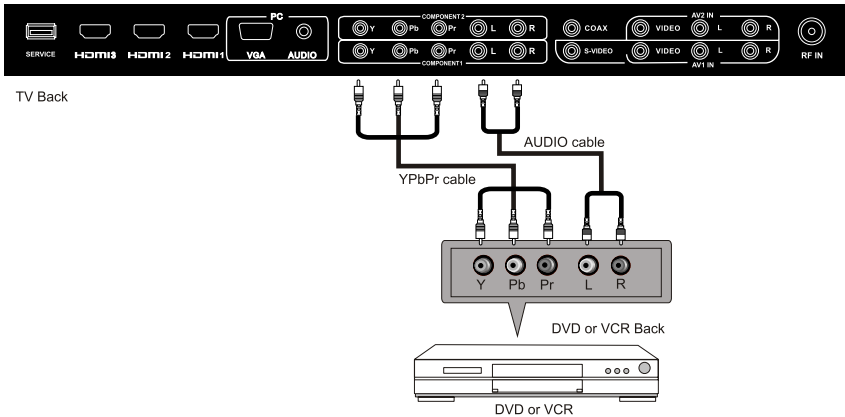

## VGA(PC) Connection

Connect the RGB output of the PC to the VGA(PC) jack on the set. Connect the AUDIO output of The PC to the PC AUDIO jack on the set. Select the RGB input source with using SOURCE button on the remote control.

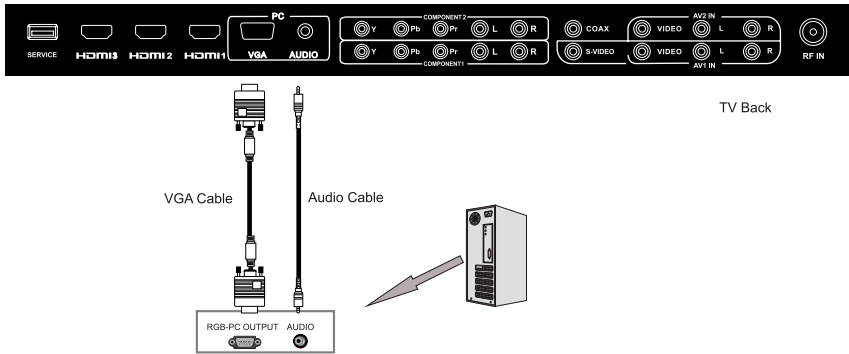

## Service Port Function

Service port: (For factory uses only.)

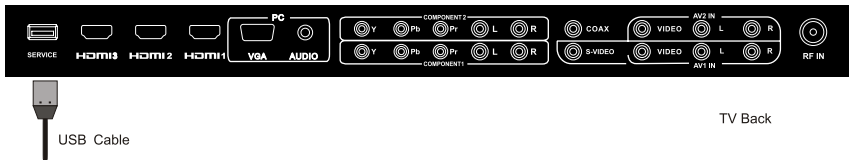

## TV INSTALLATION

### HDMI Connection

HDMI plug which replaces the HDMI connection allows transfer of all audio/video/control signals through one cable only. These signals are transferred in digital.

English

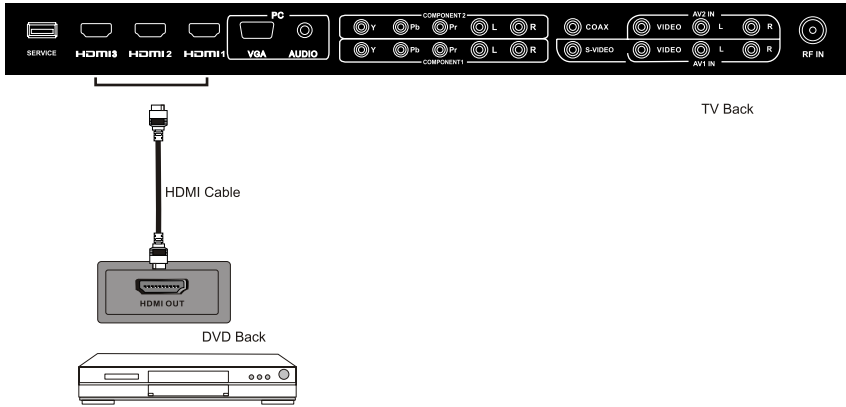

## 8. REMOTE CONTROL

### Remote control instructions in TV mode

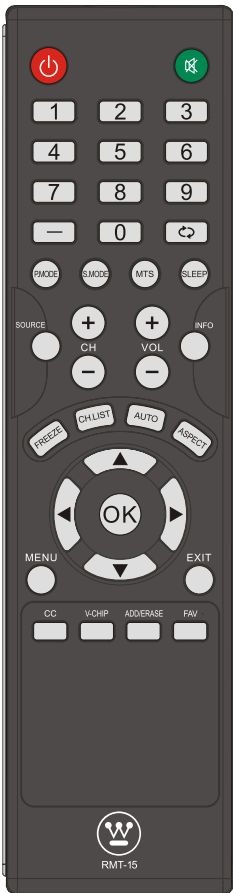

#### POWER

Turn the LCD TV ON or OFF.

#### MUTE

Press to mute the sound. Press again or press VOL+ to un-mute the TV.

#### NUMBER BUTTONS

Press 0-9 to directly change the TV channel.

Press this button to enter a program number for multiple program channel such as 2-1, etc.



Return to the previous channel viewed.

#### P.MODE

Select the picture mode.

#### S.MODE

Select the sound mode.

#### MTS

Press to adjust between available audio channel.

#### SLEEP

Set the sleep timer.

#### SOURCE

Press SOURCE to display the OSD input source, press ▲▼ to select an input source, and then press OK to confirm.

#### VOL+/VOL-

Press to increase / decrease the sound level.

#### CH+/CH-

Press to scan through channels.

#### INFO

Display information about the current channel. Press again to release it.

#### FREEZE

Press to freeze the current screen button, press again to release it.

#### LIST

Press to display the TV program list.

#### AUTO

Auto adjust (only use in the VGA source) .

#### ASPECT

Press to select Aspect Ratio.

#### THUMBSTICK( ▲ / ▼ / ◀ / ▶ / OK )

Allows you to navigate the on-screen menus and adjust the system settings to your preference.

#### MENU

Brings up the main TV menu to the screen.

#### EXIT

Exit the main TV menu to the screen.

#### CC

Press to display the closed caption.

#### V-CHIP

Setting up parental list.

#### ADD/ERASE

Add or delete favorite channels.

#### FAV

Press to display the TV favourite program list.

## REMOTE CONTROL

---

### Remote control setup

1. Open the cover.
2. Uses AAA size batteries. When inserting the batteries, make sure correct polarities "+" and "-" marks on the batteries line up correctly with compartment markings.
3. Replace the battery cover.

**To prevent battery leakage which may result in bodily injury or damage to the remote:**

1. Install all batteries correctly, and as marked on the remote control.
2. Do not mix batteries: (OLD and NEW or CARBON and ALKALINE, etc)  
Remove batteries when the remote is not used for a long period of time.

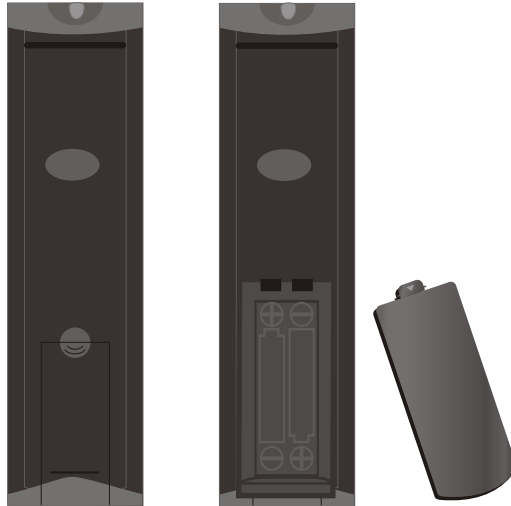



## 9.Menu Operation

### SETUP WIZARD

#### Select Language



#### Time zone

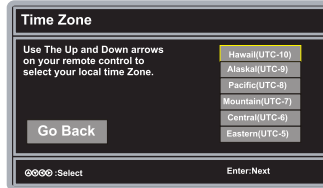

English

#### Power on Mode

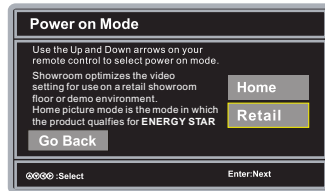
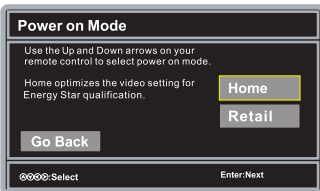

#### Setup Wizard

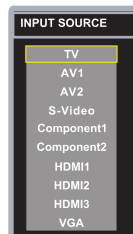
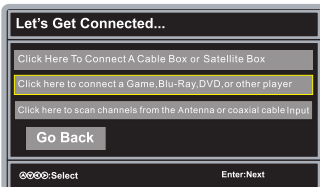
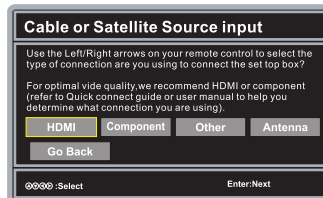
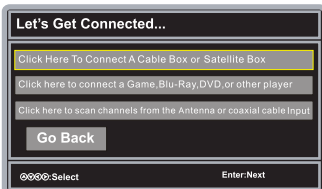

## MENU OPERATION

English

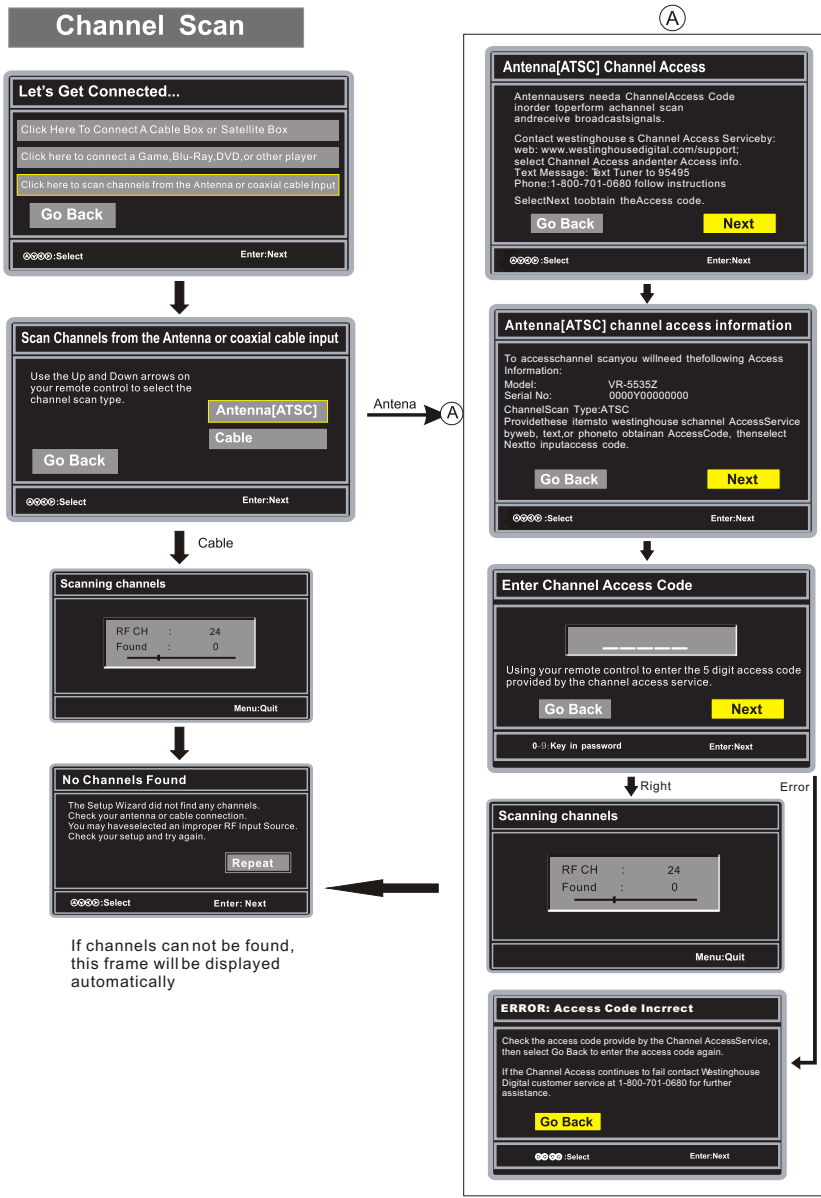

## Operating the Menu

1. Press the POWER button to turn the LCD TV on.
2. Press the MENU button on the remote control, the on-screen menu will appear on the screen.
3. Use the LEFT and RIGHT buttons to select your main menu option.

### PICTURE MENU:

Allows you to make adjustments to your picture settings. (select TV source for example)

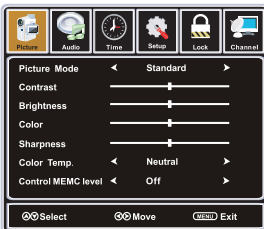

### AUDIO MENU:

Allows you to customize the audio options and effects. (select TV source for example)

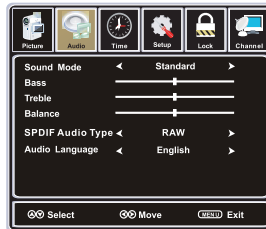

### TIME MENU:

Allows you to set up a variety of timer options. (Select TV source for example)

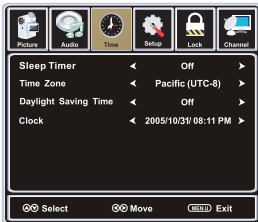

### SETUP MENU:

Allows you to set up a variety of setup options. (Select TV source for example)

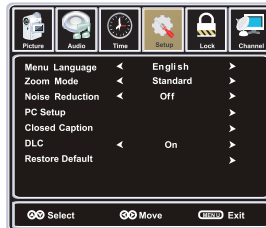

### LOCK MENU:

Allows you to set up a variety of lock options. (Select TV source for example)

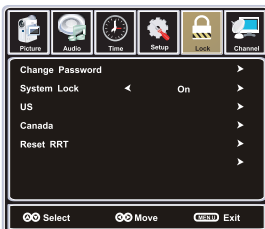

### CHANNEL MENU:

Allows you to search channels and set up a variety of channel options. (Select TV source for example)

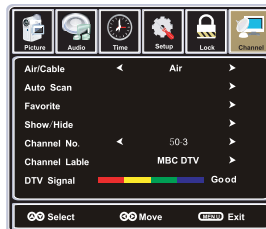

## MENU OPERATION

4. Use the UP/DOWN buttons to select an option of the sub-menu, and press the RIGHT button. While in adjustment mode, use the LEFT/RIGHT button to change the value of the item.
5. Press the MENU button to exit the menu.

Note:

Only when you input the suitable signal, the relevant items can be activated.

1. Press the POWER button to turn the LCD TV on.
2. Press the MENU button on the remote control, the on-screen menu will appear on the screen.
3. Use the LEFT and RIGHT buttons to select your main menu option.

English

### PICTURE Menu

Select TV source for example.

1. Press the MENU button on the remote control to display the Main menu, and use the LEFT and RIGHT buttons to select the PICTURE.
2. Use the UP and DOWN buttons to highlight an individual PICTURE option, use the LEFT and RIGHT buttons to change the setting, and press the MENU to exit the menu.

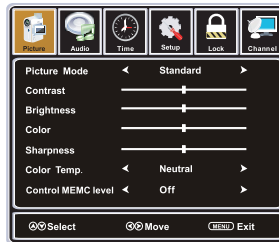

The PICTURE menu includes the following options :

#### Picture Mode

Cycles among picture display modes: Standard, Dynamic, Movie, User.

#### Contrast

Controls the difference between the brightest and darkest regions of the picture.

#### Brightness

Controls the overall brightness of the picture

#### Color

Control the color.

#### Sharpness

Increase this setting to see crisp edges in the picture; decrease it for soft edges .

#### Color Temp.

Cycles among color temp: Neutral, Warm, Cool.

#### Control MEMC level

Control the MEMC of the picture: Off/Low/Medium/Strong.

## AUDIO Menu

Select TV source for example.

1. Press the MENU button on the remote control to display the Main menu, and use the LEFT and RIGHT buttons to select the AUDIO.
2. Use the UP and DOWN buttons to highlight an individual AUDIO option, use the LEFT and RIGHT buttons to change the setting, and press the MENU to exit the menu.

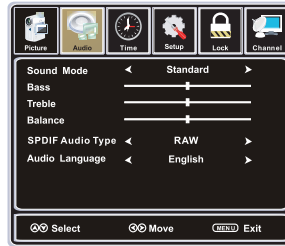

The AUDIO menu includes the following options :

### Sound Mode

Allows you to select among: User, Standard, Music, Movie.

### Bass

Controls the relative intensity of lower pitched sounds.

### Treble

Controls the relative intensity of higher pitched sounds

### Balance

To adjust the balance of the left and right sound track, or turn off the volume of the left and right sound track.

### SPDIF Audio Type

Allows you to select between: PCM and RAW.

### Audio Language

Allows you to select audio languages among: English, Français and Español.

## TIME Menu

Select TV source for example.

1. Press the MENU button on the remote control to display the Main menu, and use the UP and DOWN buttons to select the TIME.
2. Use the UP and DOWN buttons to highlight an individual TIME option, use the LEFT and RIGHT buttons to change the setting, and press the MENU button to exit.



## MENU OPERATION

The TIME menu includes the following options :

### Sleep Timer

Allows you to set up the sleep timer among: 5min, 10min, 15min, 30min, 45min, 60min, 90min, 120min, 180min, 240min and off.

### Time Zone

Allows you to set up the time zone : Pacific, Alaska, Hawaii, Eastern, Central and Mountain.

### Daylight Saving Time

Allows you to set up the daylight saving between On or Off.

## SETUP Menu

Select TV source for example.

1. Press the MENU button on the remote control to display the Main menu, and use the LEFT or RIGHT button to select the SETUP.
2. Use the UP and DOWN buttons to highlight an individual SETUP option, use the LEFT and RIGHT buttons to change the setting, and press the MENU button to exit.

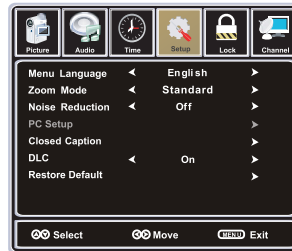

The SETUP menu includes the following options:

### Menu Language

Allows you to select menu language among: English, Français and Español.

### Zoom Mode

Allows you to select the zoom mode among: Standard, Fill, Overscan.

### Noise Reduction

Allows you to select the noise reduction mode among: Strong, Off, Weak, Medium.

### PC Setup (In VGA Mode only)

Input PC signal first, then press SOURCE button to select VGA mode, press RIGHT button to confirm.

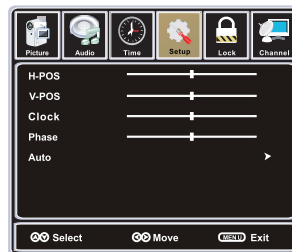

- H-Position** Allow you to use LEFT and RIGHT button to adjust the H Position.
- V-Position** Allow you to use LEFT and RIGHT button to adjust the V Position.
- Clock** Allow you to prolong the image.
- Phase** Allow you to adjust the definition.
- Auto** Select "Auto" and press RIGHT, the unit will automatically adjust all items to achieve a best effect.

**Closed Caption**

Use Down button to highlight the Closed Caption item, then press RIGHT button to enter into the following menu.

**CC Mode**

Allows you to select the CC Mode among: On, Off and CC on Mute.

**Basic Selection**

Allows you to select the basic selection among: CC1, CC2,CC3, CC4, Text1, Text2, Text3 and Text4.

**Advanced Selection**

Allows you to select the advanced selection among: Service1, Service2, Service3, Service4, Service 5 and, Service 6.

**Option**

Use Down button to highlight the "Option"item, then press RIGHT button to enter into the following menu.



Use UP and DOWN buttons to highlight the desired item, and use LEFT and RIGHT buttons to select.

**DLC**

Dynamic luminance control ON or OFF .

**Restore Default**

Restores all settings to factory settings.



## MENU OPERATION

### LOCK Menu

Select TV source for example.

1. Press the MENU button on the remote control to display the Main menu, and use the LEFT and RIGHT buttons to select the LOCK
2. Use the DOWN button to highlight the "Enter Password" item, use the numeric keys to input 4-digital password, then the screen will display the junior menu. After settings, press menu button to exit.

NOTE: The factory password is 0000.

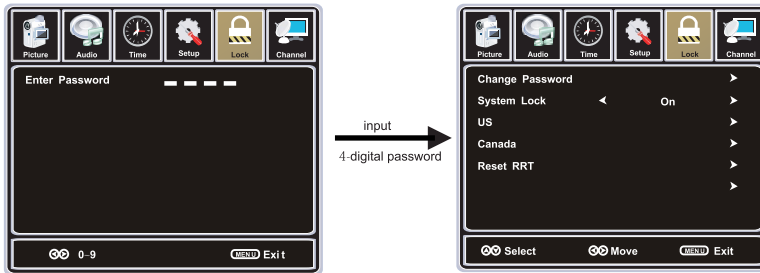

The LOCK menu includes the following options :

#### Change Password

Use DOWN button to select the "Change Password" item, then press RIGHT button to enter into the following menu. Input the new 4-digital password and input it again to confirm.

#### System Lock

Allows you to turn on or off the system lock. If you turn off the system lock, then the following items (US, Canada and Reset RRT) will be unable to use.

#### US

Use Down button to highlight the "US" item, then press RIGHT button to enter into the following menu.

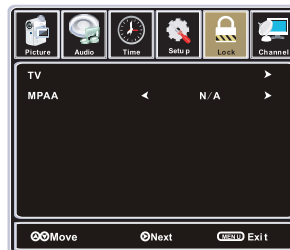



**TV**

Use Down button to highlight the "TV" item, then press RIGHT button to enter into the following menu.

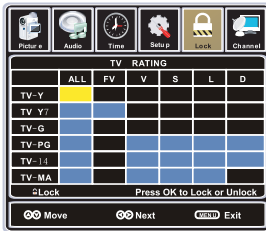

Use UP and DOWN buttons to select the desired rating and press RIGHT button to block or unblock rating.

**MPAA**

The Movie rating (MPAA) is used for original movies rated by the Motion Picture Association of America (MPAA) as broadcasted on cable TV and not edited for television.

Use UP or DOWN button to select N/A, G, PG, PG-13, R, NC-17 or X.

RATING	DESCRIPTION
G	General Audiences. Movie is appropriate for all ages.
PG	Parental Guidance Suggested. May contain material not suited for younger viewers.
PG-13	Contains content that may not be appropriate for viewers under the age of 13.
R	Restricted. Contains adult content, no one under 17 admitted without parent.
NC-17	No one 17 and under admitted.
X	Adults only.

**Canada**

Use Down button to highlight the "Canada" item, then press RIGHT button to enter into the following menu.

**Canada Eng**

Use LEFT and RIGHT buttons to select among: E, C, C8+, G, PG, 14+ and 18+

**Canada Fre**

Use LEFT and RIGHT buttons to select among: E, G, 8ans+, 13ans+, 16ans+ and 18ans+



**Reset RRT**

Allows you to reset the RRT setting.

## MENU OPERATION

### CHANNEL Menu

Select TV source.

1. Press the MENU button on the remote control to display the Main menu, and use the LEFT and RIGHT buttons to select the CHANNEL.
2. Use the UP and DOWN buttons to highlight an individual CHANNEL option, use the LEFT and RIGHT buttons to change the setting, and press the MENU button to exit.

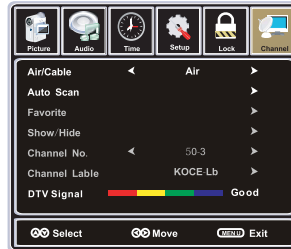

The CHANNEL menu includes the following options :

Air/Cable/QAM

Allows you to select antenna between Air, Cable and QAM.

Use Down button to highlight the "Auto Scan" item, then press RIGHT button to enter into the following menu.

If you select "Air" as input signal in Antenna item, you can press RIGHT button to search the channels automatically.



The receivable channels will be stored automatically. When searching channels, press MENU to stop.

If you select "Cable" as input signal in Antenna item, allows you to select Cable System among: Auto, STD, IRC and HRC. Use DOWN button to highlight the "Start to Scan", then press RIGHT button to search the channels automatically. The receivable channels will be stored automatically. When searching channels, press MENU to stop.

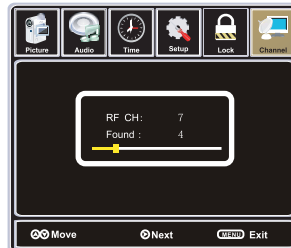

If you select "QAM" as input signal in Antenna, these frames will be displayed automatically (but these frames will be displayed only in the first scan).

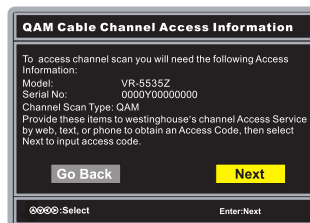

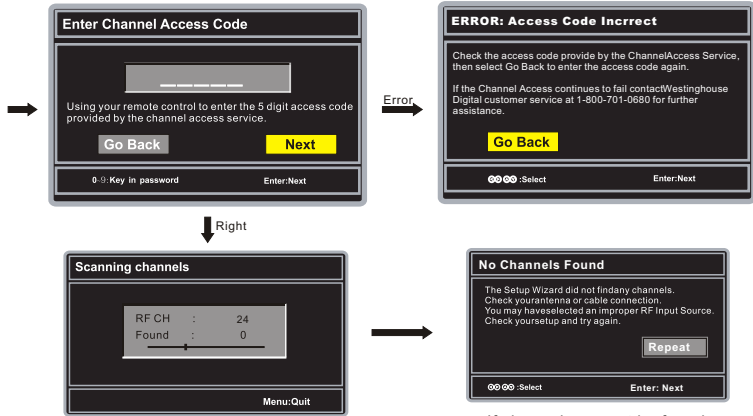

If channels cannot be found, this frame will be displayed automatically

**Favorite**

Allows you to add these channels which you desired as the favorite channels.

Use UP or DOWN button to highlight the "Favorite" item, then press RIGHT button to enter into the following menu.

Use UP and DOWN button to highlight the desired item, then press OK button to add or remove the highlighted channel as favorite.



**Show / Hide**

Allows you to show or hide the channels.

Use UP or DOWN button to highlight the "Show / Hide" item, then press RIGHT button to enter into the following menu.

Use UP and DOWN button to highlight the desired item, then press OK button to show or hide the highlighted channel.



**Channel No.**

Display the number of current channel.

**Channel Label**

Display the label of current channel.

**DTV Signal**

Display the quality of current DTV Signal.

## 10. Troubleshooting

Please check if you can solve problems by troubleshooting yourself.

Troubleshooting	Control
No signal	Please check that all cables are correctly plugged in.
No color shades	Adjust the contrast, the color and the brightness.
Stain on the screen	May be the result from a lighting signal from car, motor, neon light and other electrical devices or appliances.
Double or multiple display image	May be the result of an electrical wave disturb from other TV, Computer and Game machine or Radio.
Snow on the screen	The cables of the antenna are not correctly plugged in.
The remote control does not work	Please check the batteries order and alignment. Check that the IR of the remote control is not hidden by something.
"Zip" made noise on TV cover	Even if the display image is correct, the noise may come from an unsteady fixation of the panel.
No sound	Make sure that you have not press the MUTE button of the panel or of the remote control.

## SPECIFICATIONS

### 11. SPECIFICATIONS

This manual is only for your reference, any change to the design and specification will not be advised.

	Screen Size	55 Inch
	Display Type	TFT LCD
	Resolution(Pixel)	1920 X 1080
	Aspect Ratio	16:9
	Power Supply	AC110-240V 50/60Hz
	Power Consumption	250W
	TV System	ATSC/NTSC
	Video Input Format	PAL/NTSC
	Audio Output Power	L / R 2X8W
SUPPORT	ANTENNA	YES
	AV-IN	YES
	YPbPr - IN	YES
	HDMI - IN	YES
	VGA(PC) - IN	YES
	VGA(PC) AUDIO - IN	YES
	SCART - IN	--
	SCART - OUT	--
	HEADPHONE - OUT	--
	S-VIDEO - IN	YES
	COAXIAL - OUT	YES
	COMMON INTERFACE	--
	USB	Service Port Only
IPOD	--	
DVD	Disc Physical Format	--
	DVDVideoOutputFormat	--
Dimensions	Inc Stand (LxWxHmm)	1320x330x872mm
	Exc Sand (LxWxHmm)	1320x72x820mm
Weight	Net (Kgs)	26.5
	Gross (Kgs)	33

